

HOYT
ARCHERY



RECURVE

Owner's Manual

WELCOME TO TEAM HOYT.

Congratulations on the purchase of your new Hoyt Recurve product. We are excited and grateful to have you as a part of Team Hoyt. You will be pleased to know that you have purchased the most technologically advanced and dependable product on the market. Only the finest components go into every Hoyt bow along with over 85 years of industry leading experience in bow technology and manufacturing. With proper use and some basic maintenance, your new Hoyt Recurve product will provide you with years of great shooting and dependability.

Archery is a very enjoyable form of recreation for people of all ages and abilities. It is important to note that archery equipment, when not used properly, can create a dangerous situation, including death and serious personal injury for the archer or those around them. It is up to you to be a responsible archer protecting both you and others when enjoying this great sport. Whether you are an experienced archer or have never shot a bow, you must **READ THIS ENTIRE MANUAL CAREFULLY BEFORE USING YOUR BOW.** Following all warnings and instructions contained in this manual will help ensure you and others have the safest and most enjoyable shooting experience possible. Keep this owner's manual handy and reference it often. Should you lose this manual you can find a current manual online at www.hoyt.com . Good luck and safe shooting!

BOW OWNER'S PERSONAL INFO

Fill in the following personal bow record for your reference.

Riser Serial Number: _____

Hoyt Riser Model: _____

Riser Serial Number: _____

Limb Model: _____

Purchased From: _____

Purchase Date: _____

Length: _____ Weight: _____

IMPORTANT!

A copy of your sales receipt is required for warranty purposes.

The sales receipt, as well as the serial number, is your proof of date-of-purchase. Proof of date-of-purchase will be required if your bow ever needs warranty service.

TABLE OF CONTENTS

Recurve Bow Terminology	2
Important Safety Information	3
Required Safe Operating Parameters	6
Bow Length	7
Draw Weight	8
Bow Assembly	8
Installing Limbs	8
Shooting String Installation.....	9
Un-stringing your bow.....	10
Pro Series Limb Adjustment Systems.....	10
Pro Series Alignment System.....	12
Customized Recurve Limb Performance Technology.....	13
Pivot Block Adjustment.....	14
Adjusting Weight	14
Adjusting Tiller	15
Adjusting Center Shot.....	15
Brace Height Range Chart.....	16
VertaTune Plate.....	16
Fine Tuning.....	16
Limb Maintenance.....	16
Warranty	16



RECURVE BOW TERMINOLOGY

Understanding recurve bow terminology and measuring techniques is very important in setting up your new bow. Please familiarize yourself with the following terms and measurements. Refer to them as needed. (Bow shown from sight window side of bow.)

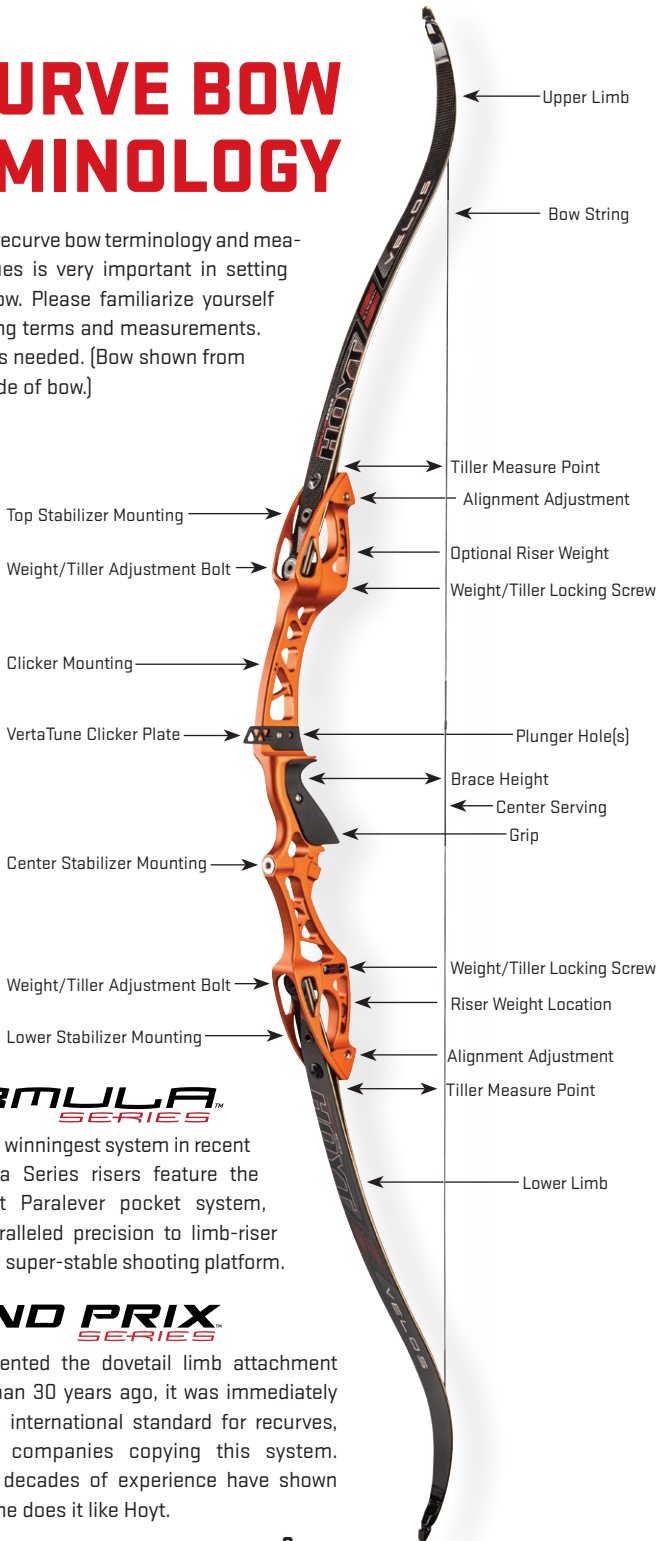

FORMULA™ SERIES

Hands down the winningest system in recent history, Formula Series risers feature the elongated Hoyt Paralever pocket system, delivering unparalleled precision to limb-riser alignment and a super-stable shooting platform.

GRAND PRIX™ SERIES

When Hoyt invented the dovetail limb attachment system more than 30 years ago, it was immediately adopted as the international standard for recurves, with all other companies copying this system. However, three decades of experience have shown one thing: No one does it like Hoyt.

WARNINGS

TO AVOID SERIOUS INJURY OR DEATH, FOLLOW THE SAFETY INFORMATION IN THIS MANUAL.

This manual contains several safety warnings and instructions preceded with **⚠️WARNING**, **⚠️CAUTION** or **NOTICE**. These signal words are designed to draw attention to important safety information. **⚠️WARNING** indicates a hazardous situation which, if not avoided, could result in death or serious personal injury. **⚠️CAUTION** indicates a hazardous situation, which, if not avoided, could result in moderate or minor personal injury. **NOTICE** addresses safety practices not related to personal injury.

⚠️WARNING

**READ THIS MANUAL CAREFULLY BEFORE HANDLING OR USING YOUR HOYT BOW.
YOU ARE RESPONSIBLE FOR ARCHERY SAFETY.**

Read and follow all warnings and guidelines for safe operating parameters at
www.hoyt.com/safetyandwarnings

The warnings contained within this owner's manual were current at time of printing. For the most up to date list of warnings please visit: www.hoyt.com/safetyandwarnings

⚠️WARNING: Always read the warning labels and manufacturer's instructions of all products being used in conjunction with a Hoyt bow, including but not limited to all archery accessories and components directly attached to the bow or used in conjunction with the bow such as targets, arrows, broadheads, release aids, etc.

⚠️WARNING: It is critical that your bow is set up and functioning within the bow's required safe operating parameters prior to use. Hoyt recommends that only a Genuine Hoyt Retailer setup and inspect your archery equipment to ensure that it is set up within the bow's safe operating parameters. (see page 6 for definition of Hoyt Bow Safe Operating Parameters).

⚠️WARNING: Carefully inspect your bow before each use. Before you handle or shoot your bow, carefully inspect the condition of your bow, accessories, arrows, and your release aid/finger tab, to ensure they are in good and proper working condition. Any suspected damage to your bow should be inspected by Hoyt or a Genuine Hoyt Retailer for possible repair or replacement.

⚠️WARNING: Before you handle or shoot your bow or other archery products, Hoyt recommends that you be trained and instructed in proper use by a certified archery coach. Sources such as USA Archery (www.teamusa.org/usa-archery/coach-ing/find-an-instructor-or-coach), the National Field Archery Association (NFAA) <https://www.nfaausa.com/state-organi-zations>, and The Archery Trade Association (ATA) <http://www.archery360.com/> have contact information for certified archery coaches in your area. Other archery associations in your area or country may also have suitable programs.

⚠️WARNING: An adult should always supervise minors when they are handling or shooting a bow.

⚠️WARNING: Never use alcohol or drugs while handling or shooting your bow.

⚠️WARNING: Always wear safety glasses when handling or shooting your bow.

WARNINGS

⚠️WARNING: Always use a bowstringer when stringing or unstringing a recurve bow (see page 9 for shooting string installation).

⚠️WARNING: Never let go of the bow handle while drawing the bow, holding the bow at full draw, or shooting the bow. It is important that you are able to maintain a consistent and secure grip on the bow handle without slippage of your hand on the bow grip. Use of items such as hand lotions, sunscreens, and insect repellents may limit your ability to maintain control of the grip.

⚠️WARNING: Always ensure that the area around your bow is clear of any and all obstructions to prevent items from being caught in the moving parts of the bow. When shooting your bow, never wear loose clothing, jewelry, or other items worn on your body that may get caught in the bow or bow string when the bow is shot.

⚠️WARNING: Never point or aim a bow at another person. Be sure of your target and what lies beyond. Never shoot arrows straight up into the air. Make sure that the path from where you are shooting to the target and beyond is free from people and obstructions. The view that you see when looking through your sight while shooting (the sight picture) may not clearly show the trajectory path of the arrow.

⚠️WARNING: Never dry fire your bow. To dry fire your bow, means to shoot the bow without an arrow. Never try drawing a bow that is too heavy for your strength or that does not fit your draw length as this could lead to an unintentional dry fire. A dry fire could cause your bow to break and cause death or serious injury to you or others. If your bow is dry-fired there could be both seen and unseen damage and it should be returned to Hoyt or taken to a Genuine Hoyt Retailer for inspection before any further use.

⚠️WARNING: Never loosen your limb weight adjustment bolts (Tiller Bolts) more than 6 turns from the bottomed-out position as it could cause the bow to violently disassemble.

⚠️WARNING: Do not perform any maintenance, adjustments, or have any work performed of any kind on any part of your bow while drawing or during any other part of the shooting cycle. Do not allow others to work on or touch any part of your bow during the shooting cycle.

⚠️WARNING: Never shoot a bow with the incorrect arrow size (spine) or the incorrect arrow length. Shooting an incorrect arrow size or length could cause your arrow to break and cause serious injury to you or others. Refer to the specific arrow manufacturer's arrow selection chart to select the correct arrow size and length for your setup.

⚠️WARNING: Never shoot a damaged arrow. Before each shot, inspect your arrows for damage. See the specific arrow manufacturer's warnings and instructions on proper arrow inspection methods. Discard all damaged arrows.

⚠️WARNING: Never mechanically alter or modify your bow. Drilling holes, cutting, filing, or sanding are examples of mechanically altering your bow which will likely cause the bow to break and could cause death or serious injury.

WARNINGS

⚠️WARNING: Never draw or shoot a bow with frayed, worn, or damaged strings as it could break. Frayed, worn, or damaged bowstrings should be immediately replaced by Hoyt or a genuine Hoyt retailer before the bow is used. Only Genuine Hoyt or Fuse-branded strings should be used on your bow. Carefully inspect the string each time before shooting your bow. Hoyt recommends that you replace the string on your Hoyt bow after 2,000 shots or after two years, whichever comes first.

⚠️WARNING: Never draw or shoot your bow without all string accessories (kisser button, nock points, string silencers) properly installed and secured to the string. Hoyt recommends that only a Genuine Hoyt Retailer install all string accessories (see page 6 for definition of Hoyt Bow Safe Operating Parameters).

⚠️WARNING: Never expose your string to sharp objects such as knives or broadheads, or direct heat sources such as open flame or extremely hot objects as they could easily cut or cause the string to break.

⚠️WARNING: Only use Genuine Hoyt manufactured replacement parts. Only Hoyt or a Genuine Hoyt Retailer should perform replacement of damaged parts. Failure to heed this warning could result in death or serious personal injury or death to yourself or bystanders.

⚠️WARNING: Never expose your bow to extreme heat or prolonged moisture. Damage can occur to your bow from heat exposure, prolonged exposure to moisture and improper storage.

⚠️WARNING: Cancer and Reproductive Harm – www.P65Warnings.ca.gov.

⚠️WARNING: When handling and using a bow, including all stages of the bow being drawn to full draw, the bowstring being released, or the bow being let down, the archer and all bystanders must keep all body parts outside of the path of the bowstring and away from all moving parts.



REQUIRED SAFE OPERATING PARAMETERS

⚠️WARNING: It is critical that your bow is set up and functioning within the bow's required safe operating parameters prior to use. Hoyt recommends that only a Genuine Hoyt Retailer setup and inspect your archery equipment to ensure that it is set up within the bow's safe operating parameters. After your bow is set up within the bow's required safe operating parameters, the bow should be tuned for improved accuracy based on your shooting style and form, the arrow type and size used, and all other accessories used.

LIMB WEIGHT ADJUSTMENT BOLT (TILLER BOLTS) SETTINGS

All Hoyt Recurve bows have an adjustable limb system that allows the bow's peak draw weight to be adjusted within the specific bow's available range. Your bow's peak draw weight can be adjusted within the bow's range by turning the bow's top and bottom limb weight adjustment bolts equally (see photo A). If Tiller Bolt does not turn easily, refer to the next section (Tiller Bolt Lock-Down) before adjusting the Tiller Bolt.



TILLER BOLT LOCK-DOWN PROCEDURE

Hoyt recurve risers are equipped with a locking tiller bolt feature to prevent the tiller bolt from moving after you have it set in the desired position. Once you have your tiller bolt in the desired position, follow the steps below to lock it down:

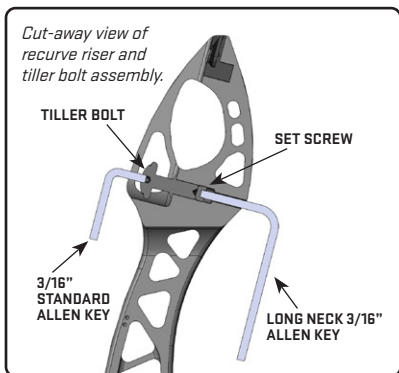

1. Hold the tiller bolt in place with a standard 3/16" Allen Key.
2. Insert a long neck 3/16" Allen Key (provided with your Hoyt riser) into the hole on the backside of the riser, directly opposite the tiller bolt, until it engages the set screw.
3. Tighten the set screw against the tiller bolt by turning the long neck Allen Key in the clockwise direction while holding the tiller bolt in place (as described in step 1).
4. Once step 3 is complete the tiller bolt is locked down and should not move.

To adjust or remove the Tiller Bolt, follow these steps:

1. Hold the tiller bolt in place with a standard 3/16" Allen Key.
2. Insert a long neck 3/16" Allen Key (provided with your Hoyt riser) into the hole on the backside of the riser, directly opposite the tiller bolt, until it engages the set screw.
3. Loosen the set screw by turning the long neck Allen Key in the counter clockwise direction while holding the tiller bolt in place (as described in step 1).
4. Once step 3 is complete the tiller bolt is no longer locked down and can be adjusted or removed.

⚠️WARNING: Never loosen your limb weight adjustment bolts (Tiller Bolts) more than 6 turns from the bottomed-out position as it could cause the bow to violently disassemble.

REQUIRED SAFE OPERATING PARAMETERS

ATTACHED BOW ACCESSORIES

Your Hoyt bow is equipped with various accessory mounting locations to allow accessories such as sights, arrow rests, and stabilizers to be attached to your bow. When attaching an accessory to your bow, follow all accessory mounting and use instructions provided by the accessory manufacturer. Ensure that all accessories are specifically right handed or left handed to match your bow where applicable and that all mounting hardware is securely tightened. Ensure that all attached accessories are clear of string and arrow flight path when the bow is shot.

ARROW REST SETTING

There are many different arrow rest designs and styles. Ensure the arrow rest is right handed or left handed based on your bow. On all Hoyt Recurve bows, arrow rests should be positioned on your bow so that your arrow fletchings completely clear the bow riser when the bow is shot. Always follow and use the specific arrow rest manufacturer's instructions for correctly setting up the arrow rest for proper function and tuning.

ARROW LENGTH SETTING

For all Hoyt Recurve bows, the required safe operating length/ position of the arrow in relationship to the arrow rest when set-up within the safe operating parameters is when the tip or end of the arrow, measures a minimum of 1" measured from the center of the rest mounting hole to the tip or end of the arrow (see photo B). Draw lengths vary from person to person, therefore the same arrow might not be in the safe operation position for all shooters.

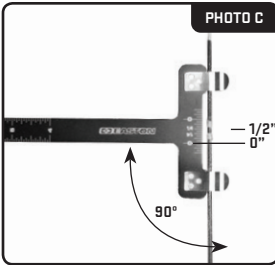
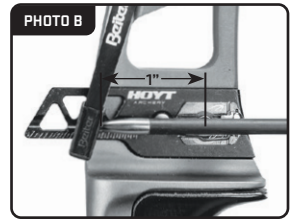

NOCKING POINTS

All bows require the use of a nocking point device to properly locate the arrow onto the bow string in relationship to the arrow rest. For all Hoyt Recurve bows, the required safe operating position of the nocking point device is when the arrow is attached to the bow string and resting on the arrow rest, the arrow will be between 0" - 1/2" above square (see photo C). Depending on poundage of limbs and draw length, you could possibly see higher than 1/2" of a nocking point. Only use a high quality archery serving material for installing a "tied-on" nocking point (see photo D for an example of a "tied-on" nocking point).

OTHER STRING ACCESSORIES

Other string accessories such as string silencers, kissers buttons or any other devices attached to the bow string of your bow must be installed in such a way that they cannot move or come off of the bow string during shooting. Hoyt recommends that only a Genuine Hoyt Retailer install and set-up any string accessories on your Hoyt bow.

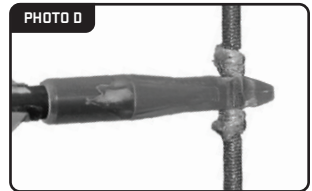

BOW LENGTH

Bow length is the distance from the tip of the top limb to the tip of the bottom limb of an unstrung bow with the tape following the limbs and going straight across the riser. Depending on which riser length and limb length you choose, you can tailor your bow to your specific needs. Refer to the chart on the next page to determine your bow length.

RISER LENGTH	SHORT LIMBS	MEDIUM LIMBS	LONG LIMBS
25"	66"	68"	70"

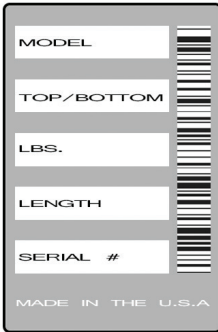

DRAW WEIGHT

To determine the weight on your Hoyt bow, refer to the limb specifications located on each limb.

The weight marked on the limb is measured at a 28" standard A.T.A. (Archery Trade Association) draw length. A.T.A. draw length is measured at 26 1/4" to the throat of the bow grip plus 1 3/4". This produces an industry standard by which draw weights are measured.

Note: All limb weights are indicated for a 25" riser. Actual limb weight depends upon draw length, brace height, riser length and limb bolt setting.

BOW ASSEMBLY

INSTALLING LIMBS

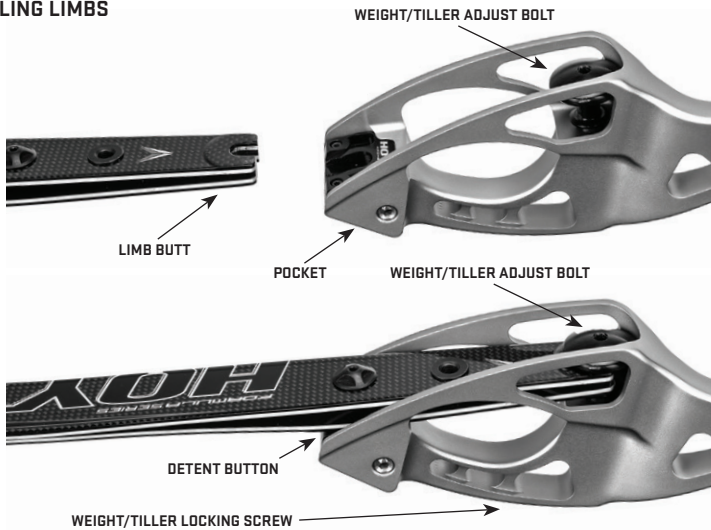

Carefully align the limb dovetail bushing with the corresponding slot in the riser pocket. Push the limb into the pocket until the detent button engages. You will feel or hear a light "click" when this occurs, and the limb will stay in place under its own weight when fully seated. It is normal at this stage for there to be vertical movement possible with the limb.

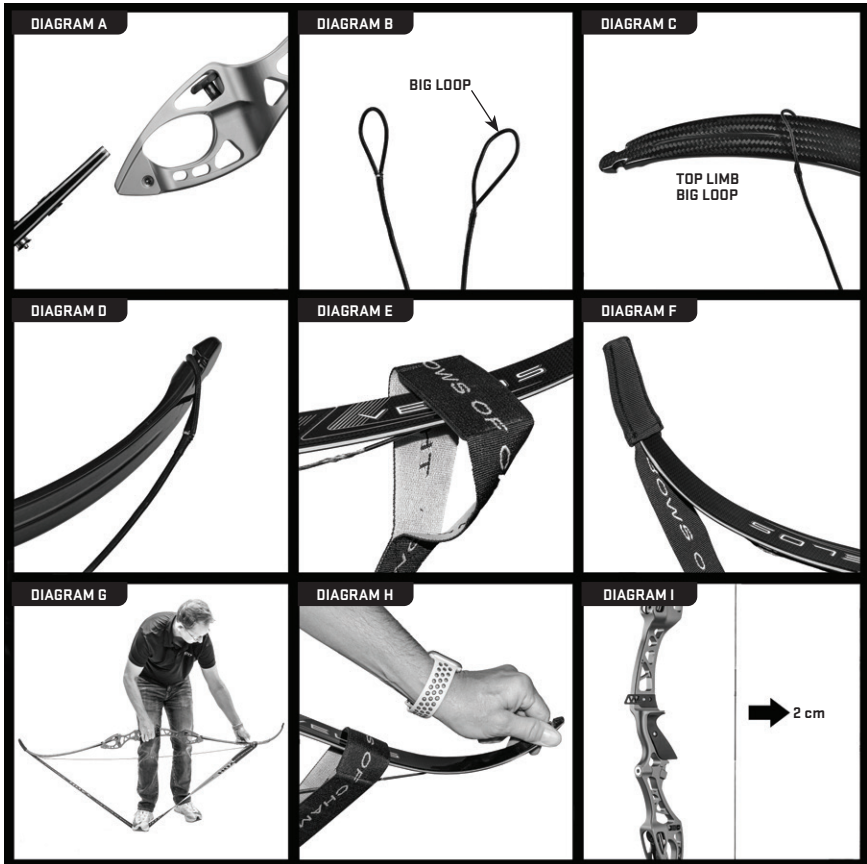

⚠WARNING: Always use a bowstringer when stringing or unstringing a recurve bow.

SHOOTING STRING INSTALLATION

(Installation for Hoyt stringer, for all other stringers, see specific manufacturer's instructions)

1. Verify that you are installing the correct length and type (material, strand count and construction) of string for the bow. Carefully inspect the string for damage or any knots or tangles that may have resulted from storage or handling.

2. Correctly made recurve strings have a larger and smaller loop (**diagram B**). The larger loop is intended for the top limb.

- Pull the larger end loop over the top limb tip (**diagram C**).
- Slide the loop down the limb so it is approximately six inches from the limb tip.
- Place the smaller end loop on the bottom limb string groove (**diagram D**).

3. With the bottom end loop securely in the bottom limb string groove, slide the fabric or cup section (**diagram F**) [depending on the model of the recurve bow stringer] over the string side of the bottom limb. Then slide the limb gripper component over the top limb, place it approximately six inches from the limb tip (**diagram E**). Make sure the rubber component rests against the

target side of the limb and that the cord that attaches the top and bottom pieces of the stringer is not tangled and is routed on the string side of the bow.

4. Stand and hold the bow horizontally (**diagram G**) with the recurve bow stringer cord should be hanging towards your feet. As shown in the photo, step on the cord with both feet while pulling up on the bow with one hand so the cord is tightened, flexing the limbs. While maintaining tension on the bow, slide the top end loop of the bowstring up the limb and secure it in the top limb string groove (**diagram H**). Once the string is in place, carefully relax the bow stringer cord by slowly letting the bow down. The shooting string will tighten and hold the bow at brace height.

5. Carefully inspect the shooting string and verify that it is securely in the string grooves, and then remove the recurve bow stringer.

6. Without an arrow, pluck the bowstring about one or two inches to “seat” the limbs. This completes the assembly procedure (**diagram I**).

⚠WARNING: Never dry fire your bow. To dry fire your bow, means to shoot the bow without an arrow.

8. Carefully inspect the string for excessive wear and damage. Apply string wax as needed.

⚠WARNING: Never draw or shoot a bow with frayed, worn, or damaged strings as it could break.

UNSTRINGING A RECURVE BOW

1. Place the bottom fabric or plastic cup (depending on the model) on the bottom limb tip, the cord must be routed on the shooting string side of the limb.

2. Place the top section of the recurve bow stringer over the top limb, the limb gripper component should rest on the target side of the limb, approximately six inches away from the limb tip.

3. While standing up, with one hand hold the bow in the horizontal position with the shooting string parallel to the ground, as if the bow was pointed straight upward. The recurve bow stringer cord should be hanging towards your feet.

4. Simply step on the cord with both feet. Simultaneously pull up on the bow with one hand so the cord is tightened. Flexing the limbs as if it was being drawn, slide the top end loop of the bowstring down the limb. Once the shooting string is relaxed, let the bow down and the shooting string and limbs will relax, and the bow will be in the unstrung position. Do not pull the limbs further than needed to relax the string.

5. Carefully remove the shooting string by first sliding the top loop down the limb, with enough slack in the string, remove the bottom end loop, then slide the top end loop up the limb and remove the string.

6. To keep the shooting string from losing its twists and adjusted length, clip or weave the top and bottom end loops together so the string will not become untwisted. Carefully inspect the string for excessive wear and damage.

PRO SERIES LIMB ADJUSTMENT SYSTEMS

Hoyt's Pro Series Limb Adjustment Systems allow an archer to adjust each limb to be perfectly balanced throughout the entire draw cycle. String your bow and pay attention to the limb tips.

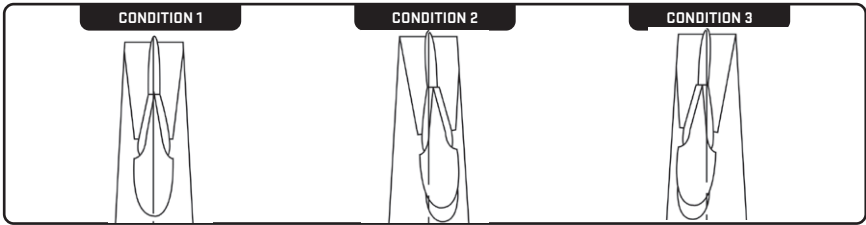

CONDITION 1: If the limb tips are sitting in the middle of the limb then no adjustment is needed. (See condition 1.)

CONDITION 2: Unstring your bow and remove your limbs (See page 9). If your limb tip is to the right, remove one or possibly two shims from the left adjustment block and place them under the right adjustment block. This will move the limb tip to the center of the limb. To remove the adjustment block simply remove the adjustment screw with an appropriate size Allen wrench. Remove the shims as needed, and place under the opposite adjustment block. Replace both adjustment blocks back into the Pro Series limb adjustment assembly and secure them with the Allen wrench. Note: do not over tighten. Over tightening the adjustment screws can cause damage yielding the adjustment system unusable.

CONDITION 3: Unstring your bow and remove your limbs (See page 9). If your limb tip is to the left, remove one or possibly two shims from the right block and place them on the left block. This will move the limb tip to the center of the limb.

The shims are 0.005" thick. You should never place more than 5 shims on one adjustment block. Placing more than 5 shims on one side could cause the limb to not fully engage into the dovetail dowel detent.

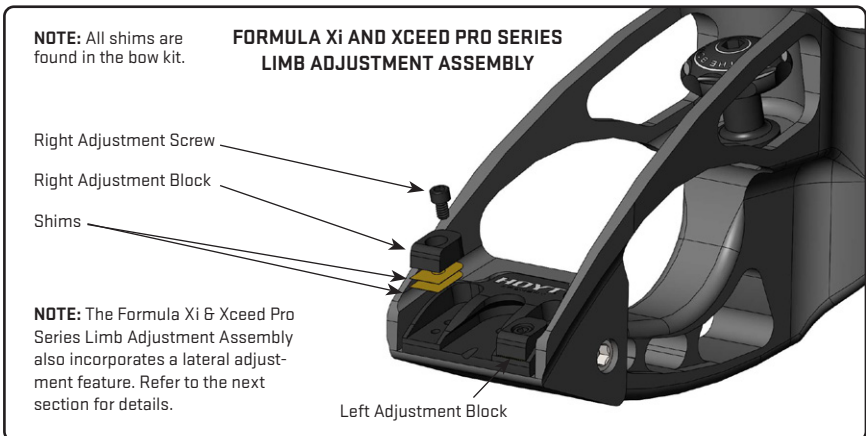

PRO SERIES ALIGNMENT SYSTEM

Hoyt's limb pocket designs are the most precise, reliable pocket systems available today. These systems will maintain correct settings in the most severe conditions. Out of the package, Hoyt bows are factory pre-aligned and lateral adjustment is optional when used with Hoyt limbs. In general, the vast majority of setups do not require lateral alignment adjustments. Adjustments should not be made before the bow has been shot a minimum of 100 shots. This will allow the mating surfaces of limbs and riser to correctly seat to each other.

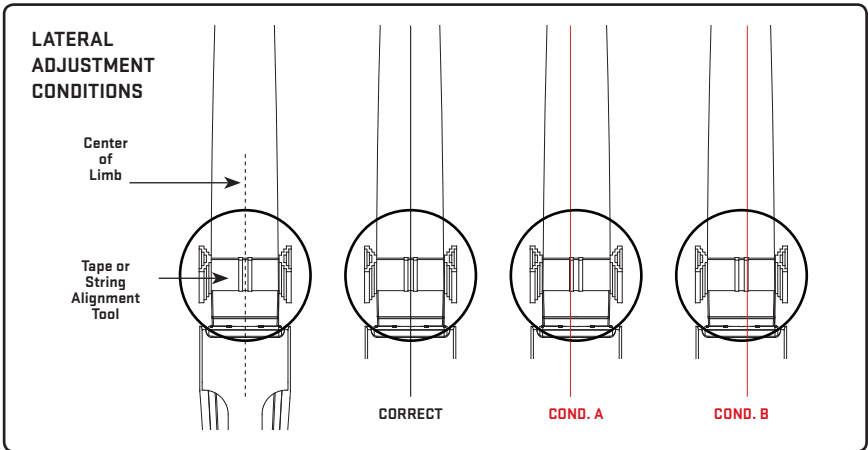

To make a lateral adjustment, follow these directions:

1. With your bow in the strung position, place a piece of masking tape horizontally, approximately 4" (10 cm) from the end of the riser on the archer's side of both limbs.
2. Locate the center of the limb with a measuring tape and draw a vertical center line on the masking tape.
3. Measure 1/16" (approx. 2 mm) from the drawn vertical center line and draw additional vertical lines on both left and right sides. (Beiter Gauges can also be used for aligning your bow.)
4. If the bow string lines up with the center line, your dowels are properly aligned. If you notice conditions A or B, proceed with the following directions for the Formula Xi or Xceed. Be certain to follow the directions for your particular bow model.

For Formula Xi and Xceed:

5. **Instructions for CONDITION A:** Loosen the right side alignment locking set screw and tighten the left side alignment locking set screw until the string is in the center of the lines.
6. **Instructions for CONDITION B:** Loosen the left side alignment locking set screw and right side alignment locking set screw until the string is in the center of the lines.
7. Once the string is in proper alignment then re-tighten the set screws.

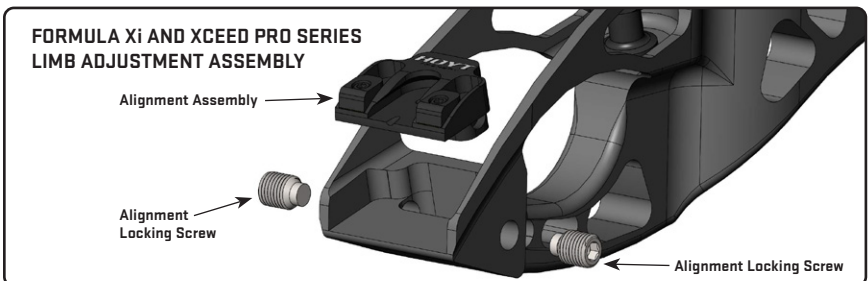

LIMB ROCKER ADJUSTMENT SYSTEM

(PATENT PENDING)

Hoyt's Limb Rocker Adjustment System allows you to change the feel of your bow during the last few millimeters of your draw without changing the draw weight. By adjusting the position of the limb rocker it will change your string tension at full draw, effectively changing the feel of your bow and how you pull through the clicker. This revolutionary system has three settings to choose from allowing you to customize how your bow feels:

1. PERFORMANCE SETTING

This setting is the furthest outboard position, or the furthest away from the grip and closest to the limb tip. With the limb rocker in this position you will have the highest string tension which will result in a more aggressive feel as you pull through the clicker. This is ideal for high pressure situations where you may experience extra adrenaline and strength and can benefit from a more aggressive feel to prevent you from pulling through the clicker too quickly.

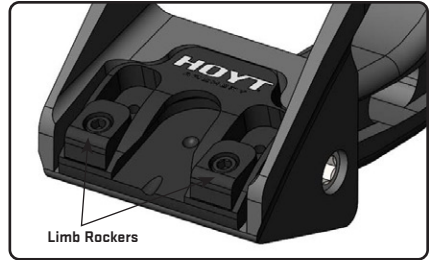

PERFORMANCE POSITION

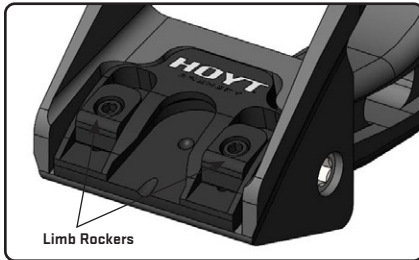

HYBRID POSITION

2. HYBRID SETTING

This setting is the middle setting. With the limb rocker in this position you will have medium string tension for a combination of performance and smoothness when pulling through the clicker.

3. SMOOTH SETTING

This setting is the furthest inboard position, or the closest to the grip of the bow. With the limb rocker in this position you will have the lowest string tension of the three positions resulting in a smoother, "lighter" feel as you pull through the clicker.

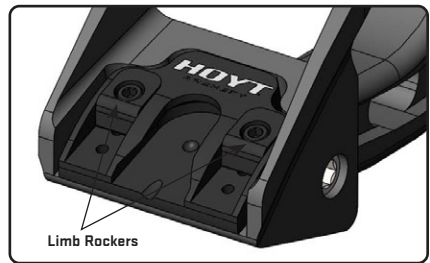

SMOOTH POSITION

Hoyt recommends you experiment with each of these three positions to find the setting that feels and performs the best to you, allowing you to shoot higher, more consistent scores.

Note: Always make certain that each of the limb rockers are in the same position before shooting your bow.

PIVOT BLOCK ADJUSTMENT

(AVAILABLE ON ARCOS AND XAKT)

Most Hoyt riser and limb combinations do not require adjustment. The riser dovetail pocket is factory aligned and should only be adjusted by a qualified equipment technician. One full sweep of the block to the left or right will result in a corresponding .020" of lateral limb adjustment at the dovetail.

Attention: Remove the left and right locking screws (see photo below) before making any adjustments. Do not lose the locking screws. Adjustments may be made with the bow in a strung position, however, Hoyt recommends unstringing the bow to reduce wear on the paint finish of the limbs.

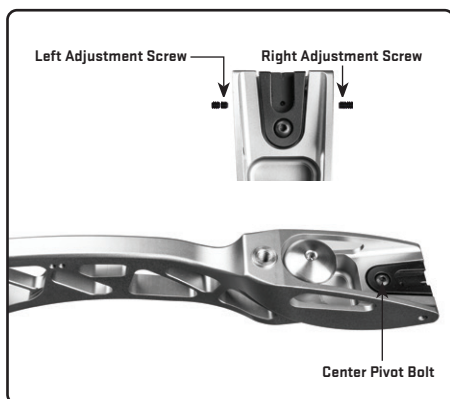

Do not attempt to adjust or remove the center pivot bolt on the alignment block.

With the locking screws removed, access the adjustment screws to make adjustments:

- Removing turns from the right side screw and adding an equal number of turns to the left side screw (viewed from the face or archer side of the riser) will move the limb tip to the LEFT.
- Removing turns from the left side screw and adding an equal number of turns to the right sidescrew (viewed from the face or archer side of the riser) will move the limb tip to the RIGHT.

• Once the proper alignment is achieved, you should snug BOTH alignment bolts against the dovetail block to the tightened position. Then, replace the locking screws and snug them tightly.

Adjustments can be made to the string to adjust brace height. Adding twists will increase the brace height while removing twist will decrease the brace height. Generally, Hoyt does not recommend less than 10 twists in a string. Optimum brace height is one that gives a smooth bow action, good arrow flight, tight grouping and often yields the quietest shot.

ADJUSTING WEIGHT

⚠WARNING: Never loosen your limb weight adjustment bolts (Tiller Bolts) more than 6 turns from the bottomed-out position as it could cause the bow to violently disassemble.

Hoyt Recurve bows are adjustable over a range of approximately 10%. Factors which affect this include limb length, limb construction, limb design and brace height.

1. Unstring the bow using an appropriate recurve bow stringer (see pg. 9).
2. Using the longer of the two supplied Allen wrenches; loosen the tiller bolt locking screw (see instructions on pg. 6). If you plan to increase weight you will need to loosen this screw by more turns than you plan to add to the tiller screw.
3. Turn the weight/tiller adjustment bolt clockwise to increase bow weight. Turn it counter-clockwise to decrease bow weight.

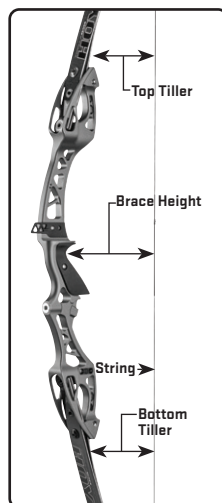

- Using both Allen wrenches, and holding the tiller bolt in place, re-lock the tiller bolt locking screw.
- Restraining the bow using an appropriate recurve bow stringer (See page 9).

Note: From the bottomed out position, the tiller bolt should only be backed out to a maximum of six complete turns. If tiller bolt is backed out more than six turns damage to the bow or limbs may occur and warranty will be voided.

ADJUSTING TILLER

⚠WARNING: Never loosen your limb weight adjustment bolts (Tiller Bolts) more than 6 turns from the bottomed-out position as it could cause the bow to violently disassemble

Tiller is a measurement which indicates the weight relationship of the top and bottom limb. This static measurement effects bow reaction and aiming. It is easily measured by noting the difference between the top limb butt to the string, and the bottom limb butt and the string. The difference (if any) is the tiller.

The degree of desirable tiller will vary from archer to archer, depending upon factors such as grip pressure, finger pressure, desired tuning pattern, desired aiming arc, desired bow reaction and more. As a starting point, it is usually easiest to tune a bow with 0 to 3/8" of tiller (distance from bottom limb to string is equal to that of the top limb, or less, by up to 3/8").

Typically, for most shooters with normal finger and hand pressure, anywhere from 0 to 3/8" of tiller is going to yield a bow which aims easily without "pulling" high or low, and which shoots more quietly. Measure the tiller as shown in the diagram on the bottom of page 13. If you wish to increase tiller without affecting bow weight, unstring the bow (See page 9) and add turns to the bottom limb tiller bolt, then subtract the exact same number of turns from the top limb tiller bolt (see page 6 for instructions on locking and unlocking the tiller bolt before adjusting it). After re-locking the bolts and set screws, restring the bow. Do the opposite to decrease tiller. You can increase both tiller and bow weight by adjusting the bottom limb only.

ADJUSTING CENTER SHOT

The final step of tuning is to position your center shot. To start, position the arrow slightly outside of the center of the bowstring. To do that, begin by nocking an arrow and placing it on the arrow rest. Do not draw the bow, but position yourself behind the string side of the bow, looking down the arrow. Align the string down the center of the limbs and riser and check to see the position of the arrow tip relative to this line. Adjust the plunger or arrow rest until the inside edge of the arrow shaft aligns with this line.

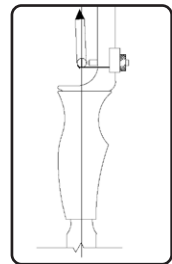

BRACE HEIGHT RANGE CHART

Riser	Limbs	Short	Medium	Long
25" Xceed, Alero, & Formula Xi	Length String Length Brace Height	66" 63.25" 8.25-8.75"	68" 65.25" 8.5-9.0"	70" 67.25" 8.75-9.5"

VERTATUNE PLATE

To install your VertaTune plate simply place the VertaTune plate into the riser and fix it to the riser by using the VertaTune bolt and washer. Note: do not over tighten the VertaTune Bolt. (See photo E) This is useful for switching from an indoor to an outdoor arrow or vice-versa and also provides an easy way to switch in a backup arrow rest (using an identical VertaTune plate, available from your Genuine Hoyt Retailer)

The VertaTune plates come in 3 configurations (high, medium & low) which allows you to change the arrow rest height for a total of 1/4" (1/8" between high and medium, 1/8" between medium and low)

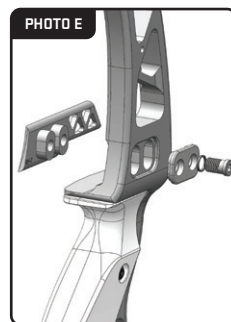

FINE TUNING

For advanced methods, see your local dealer. An additional source of detailed information is the Easton Arrow Tuning & Maintenance Guide, available online at www.eastonarchery.com.

LIMB MAINTENANCE

Hoyt limbs are very low maintenance. However, a few simple steps can help keep them looking new and prevent minor problems. The most common limb issue is loose hardware. Over time, the stainless-steel button head screw holding the limb detent system in the limb can loosen. Use an Allen wrench to periodically re-tighten this screw. Do not over-tighten. The screw is designed to be removable to allow cleaning in the event of water immersion. However, the components are corrosion resistant and normal rainfall is not a problem. Lubricant is not required on any limb component when the limbs are used in Hoyt risers.

Hoyt limbs are water-resistant. Occasionally you may apply a light coat of quality car wax to the painted surfaces to keep them looking fresh, but this is not required. Wood core limbs are potentially susceptible to moisture penetration if the protective finish is damaged (by a deep scratch, for example). The use of clear nail polish or clear automotive touch-up paint will help re-seal the wood and prevent moisture problems. After use in wet conditions, towel dry your limbs and riser to prevent water damage (do not use a heat source).

WARRANTY

RECURVE BOW RISER AND RECURVE LIMB WARRANTY. PLEASE READ THIS DOCUMENT CAREFULLY. IT CONTAINS VERY IMPORTANT INFORMATION ABOUT YOUR RIGHTS AND OBLIGATIONS, AS WELL AS LIMITATIONS AND EXCLUSIONS THAT MAY APPLY TO YOU.

Hoyt warrants to the **ORIGINAL OWNER** that Hoyt Recurve Bow Risers will be free from defects in materials and workmanship for the lifetime of the product and that Hoyt Recurve Limbs will be free from defects in materials and workmanship for two years from date of purchase. Hoyt Recurve Bow Riser and Hoyt Recurve Limb warranty is regulated under the following terms and

conditions:

1. The original owner must retain and provide an original and dated proof of purchase (sales receipt). **THIS WARRANTY IS NOT TRANSFERABLE.**

2. THE ORIGINAL OWNER MUST REGISTER THE RISER OR LIMBS WITH HOYT WITHIN 30 DAYS OF PURCHASE. To register your product, visit www.hoyt.com/warranty-registration to complete the registration process electronically, or contact Hoyt at (801) 363-2990 for assistance with registering your product.

3. All risers and limbs must have the original serial number factory-attached to the bow. The serial number must remain legible.

Exclusions from Warranty Coverage.

This Limited Lifetime Warranty covers normal use of the product, and Hoyt does not warrant and is not responsible for:

1. The use of aftermarket products/accessories that alter Hoyt's specifications or design.
2. Damage to strings, damping materials, finish (including paint, anodize, powder coat and film-dipped finishes) resulting from normal wear-and-tear.
3. If bow shows sign of misuse, alteration, or mishandling, this warranty will be void.
4. Use of arrows weighing less than 5 grains per pound of draw weight will void the warranty.
5. Damage to 'other' accessories.

OBTAINING WARRANTY SERVICE

To obtain warranty service, you must return your bow to a Genuine Hoyt Retailer. The dealer can help to determine if Hoyt factory service is required or if the dealer can complete the repair. Genuine Hoyt Retailers may provide additional services and apply additional charges for service work performed by the dealer. If the bow must be returned to the factory, **THE BOW OWNER IS RESPONSIBLE FOR THE FREIGHT CHARGES TO HOYT.** Hoyt, in turn, will pay for the same return freight of the repaired product. Before any bow is returned to Hoyt, a Return Authorization (RA) number must be obtained through a Genuine Hoyt Retailer. Bows returned to the factory without a Return Authorization number obtained from a Genuine Hoyt Retailer may be denied warranty service. If Hoyt determines, in its sole discretion, that a bow qualifies for warranty repair, Hoyt will make every effort to repair the bow. Repairs may be performed with original parts when available. Hoyt reserves the right to make part substitutions on warranty coverage for any reason. If original parts are not available, suitable replacement parts/components may be used. If the Hoyt bow is not repairable, but qualifies for warranty coverage, Hoyt will replace the bow with a bow of similar feature and product class in Hoyt's sole determination. **THERE ARE NO OTHER WARRANTIES EXPRESSED OR IMPLIED THAT EXTEND BEYOND THOSE WRITTEN HERE. NO AGENT, EMPLOYEE OR REPRESENTATIVE OF HOYT OR ITS DEALERS HAVE THE AUTHORITY TO BIND HOYT TO ANY AGREEMENT NOT HEREIN STATED.**

LIMITATION OF LIABILITY IN NO EVENT SHALL HOYT BE LIABLE UNDER ANY CIRCUMSTANCE TO YOU OR ANY OTHER PARTY FOR ANY SPECIAL, CONSEQUENTIAL, OR INCIDENTAL DAMAGES ARISING OUT OF OR IN ANY WAY CONNECTED WITH THE PRODUCTS, EVEN IF THE COMPANY OR ANY OF THE COMPANY AFFILIATES HAS BEEN ADVISED OF THE POSSIBILITY OF SUCH DAMAGES. IN NO EVENT SHALL HOYT OR ANY HOYT AFFILIATE BE LIABLE TO YOU OR ANY OTHER PARTY FOR LOSS, DAMAGE, OR INJURY OF ANY KIND BEYOND THE BOW ITSELF.

HOYT®

ARCHERY

593 North Wright Brothers Drive | Salt Lake City | Utah | USA | 84116-2887
Phone 801-363-2990 | Fax 801-537-1470 | www.hoyt.com



Follow us on Twitter!
www.twitter.com/hoytarcheryinc



Like us on Facebook!
www.facebook.com/HoytTargetArchery
www.facebook.com/HoytBowhunting



Follow us on Instagram!
www.instagram.com/HoytTargetArchery
www.instagram.com/HoytBowhunting



Subscribe to us on YouTube!
youtube.com/hoytarcheryinc

HOYT RECURVE BOW LIMITED LIFETIME WARRANTY

Hoyt recurve handles are guaranteed against manufacturing defects in materials and workmanship to the original owner for the life of the product*.

*Visit www.hoyt.com/warranty for complete warranty details or see warranty policy in owner's manual.



HOYT®

ARCHERY

Proud Partner of World Archery